



Radio | CD | MP3 | WMA

Sevilla MP38



7 648 003 310

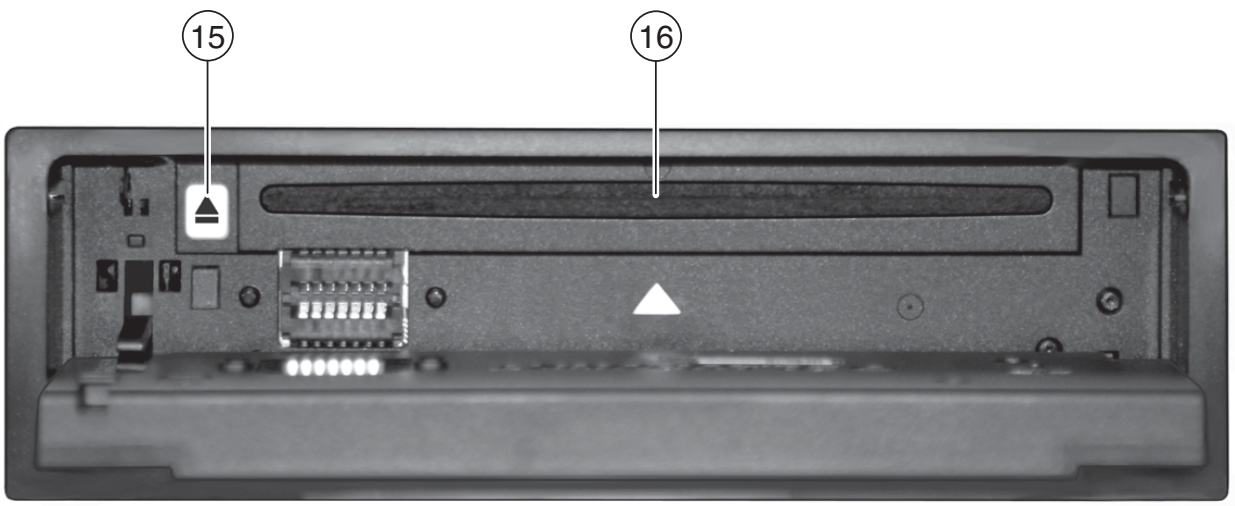
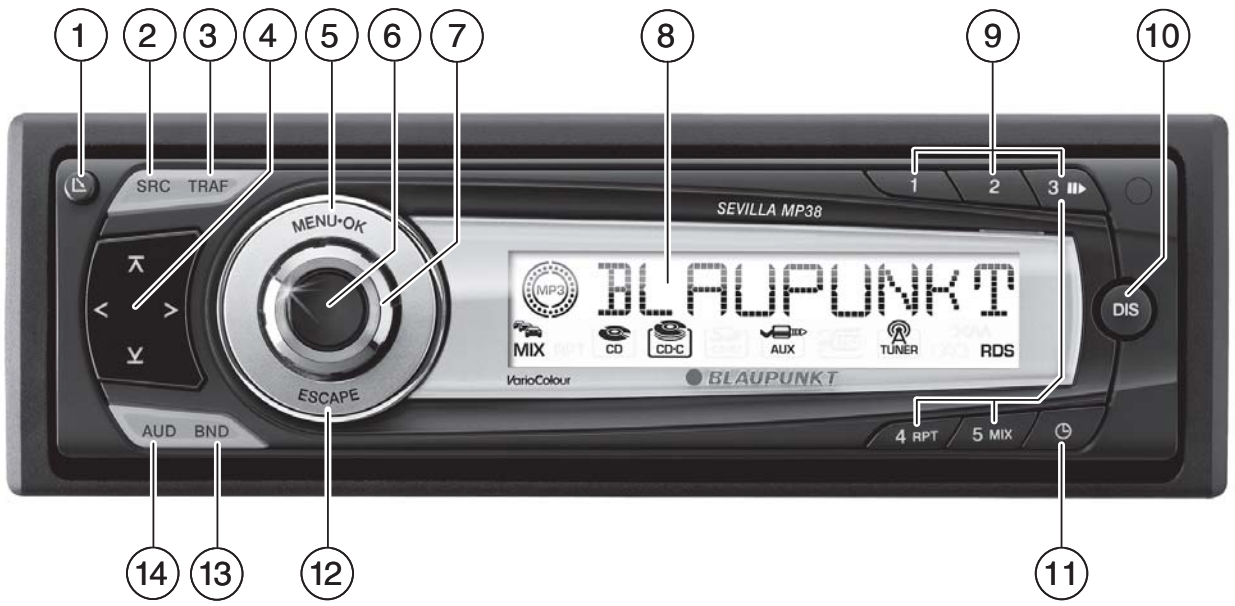

Bedienungs- und Einbauanleitung
Operating and installation instructions
Mode d'emploi et de montage
Istruzioni d'uso e di installazione
Gebruiksaanwijzing en inbouwhandleiding
Bruks- och monteringsanvisning
Instrucciones de manejo e instalación
Instruções de serviço e de montagem
Betjenings- og monteringsvejledning
Instrukcja obsługi i montażowa
Návod k obsluze a k montáži
Návod na obsluhu a inštaláciu
Инструкция по эксплуатации и установке

 **BLAUPUNKT**



- ①  button
to open the detachable control panel (flip-release panel).
- ② **SRC** button
Source selection between radio and CD and (if connected or switched on) CD changer and AUX.
- ③ **TRAF** button
Short press: Switches traffic information standby on/off.
Long press: Switches convenient RDS function on/off.
- ④ Arrow buttons
- ⑤ **MENU•OK** button
Short press: Calls up the menus for basic settings and confirms settings. Ending the scan function.
Long press: Starts the Scan function.
- ⑥ On/Off button
Short press: Switches the device on. In operation: Mutes the device.
Long press: Switches the device off.
- ⑦ Volume control
- ⑧ Display
- ⑨ Keys **1 - 5**
- ⑩ **DIS** button
Changes display contents.
- ⑪  button
Briefly displaying the time
- ⑫ **ESCAPE** button
Confirm menu item and return to the display of the MENU or AUDIO main level.
- ⑬ **BND** button
Short press: Selects the FM memory banks and the MW and LW wavebands.
Long press: Starts the Travelstore function.
- ⑭ **AUD** button, sets bass, treble, middle, balance, and fader.
Switching X-BASS on/off and adjusting it.
Selects an equalizer presetting.
- ⑮  button (Eject) for removing a CD from the device.
- ⑯ CD tray

| | | | |
|--|-----------|---|-----------|
| About these instructions | 38 | Storing stations automatically (Travelstore) | 47 |
| Symbols used..... | 38 | Listening to stored stations | 47 |
| Use as directed..... | 38 | Scanning receivable stations (SCAN) .. | 47 |
| Declaration of conformity..... | 38 | Setting the scanning time..... | 48 |
| For your safety | 39 | Programme type (PTY) | 48 |
| If you are installing device yourself.... | 39 | Optimising radio reception | 49 |
| Observe the following!..... | 39 | Configuring the display | 49 |
| Cleaning instructions..... | 39 | Traffic information..... | 50 |
| Disposal of old unit | 39 | Switching traffic information | |
| Scope of delivery | 40 | priority on/off | 50 |
| Optional equipment | | Setting the volume for traffic | |
| (not part of the scope of delivery) | 40 | announcements..... | 50 |
| Warranty..... | 40 | CD mode | 51 |
| Service | 40 | Switching to CD mode | 51 |
| Detachable control panel | 41 | Selecting tracks..... | 51 |
| Theft protection..... | 41 | Fast seek tuning (audible) | 51 |
| Detaching the control panel..... | 41 | Random track play (MIX) | 52 |
| Attaching the control panel..... | 41 | Scanning tracks (SCAN)..... | 52 |
| Switch-off time (OFF TIMER) | 42 | Repeating tracks (REPEAT) | 52 |
| Timeout function | 42 | Interrupting playback (PAUSE)..... | 52 |
| Switching on/off..... | 42 | Configuring the display | 52 |
| Adjusting the volume | 43 | Displaying CD text..... | 53 |
| Setting the power-on volume | 43 | Traffic announcements in CD mode .. | 53 |
| Quickly reducing the volume (MUTE) ... | 43 | Ejecting a CD..... | 53 |
| Telephone Audio/Navigation Audio ... | 44 | MP3/WMA mode | 54 |
| Switching the confirmation beep | | Preparing an MP3/WMA CD..... | 54 |
| on/off | 44 | Switching to MP3 mode | 55 |
| Radio mode | 45 | Configuring the display | 55 |
| Adjusting the tuner..... | 45 | Selecting a directory | 56 |
| Switching to radio mode | 45 | Selecting Tracks/Files..... | 56 |
| Convenient RDS functions (AF, REG) ... | 45 | Fast search | 56 |
| Selecting the waveband/ memory bank | 46 | Random track play (MIX) | 56 |
| Tuning into a station | 46 | Scanning tracks (SCAN)..... | 56 |
| Setting the sensitivity of | | Repeating individual tracks or | |
| station seek tuning..... | 47 | whole directories (REPEAT)..... | 57 |
| Storing stations | 47 | Interrupting playback (PAUSE)..... | 57 |

| | | | |
|--|-----------|--|------------|
| CD-changer mode | 58 | Technical data | 66 |
| Switching to CD-changer mode | 58 | Amplifier | 66 |
| Selecting CDs..... | 58 | Tuner | 66 |
| Selecting tracks..... | 58 | CD..... | 66 |
| Fast searching (audible)..... | 58 | Pre-amp out..... | 66 |
| Configuring the display | 58 | Input sensitivity | 66 |
| Repeating individual tracks or whole CDs (REPEAT) | 58 | Installation instructions | 423 |
| Random track play (MIX) | 59 | | |
| Scanning all tracks on all CDs (SCAN) .. | 59 | | |
| Interrupting playback (PAUSE)..... | 59 | | |
| Clock - Time..... | 60 | | |
| Setting the time..... | 60 | | |
| Selecting 12/24-hour clock mode | 60 | | |
| Displaying the time continuously when the device is off and the ignition is on | 60 | | |
| Sound | 61 | | |
| Adjusting the bass | 61 | | |
| Adjusting the middle | 61 | | |
| Adjusting the treble..... | 61 | | |
| Setting the left/right volume distribution (Balance) | 62 | | |
| Adjusting the front/rear volume distribution (Fader)..... | 62 | | |
| X-BASS | 63 | | |
| Adjusting the X-BASS boost..... | 63 | | |
| Equalizer presets (Presets) | 63 | | |
| Adjusting the display settings..... | 64 | | |
| Adjusting the display brightness..... | 64 | | |
| Setting the display illumination colour | 64 | | |
| Activating/deactivating demo mode... | 65 | | |
| External audio sources | 65 | | |

About these instructions

These instructions contain important information to easily and safely install and operate the device.

- Read these instructions carefully and completely before using the device.
- Keep the instructions at a location so that they are always accessible to all users.
- Always pass on the device to third parties together with these instructions.

In addition, observe the instructions of the devices used in conjunction with this device.

Symbols used

These instructions employ the following symbols:



CAUTION!

Warns about laser beam



CAUTION!

Warns about damaging the CD drive



The CE mark confirms the compliance with EU directives.

➔ Identifies a sequencing step

- Identifies a listing

Use as directed

This device is intended for installation and operation in a vehicle with 12 V vehicle system voltage and must be installed in a DIN slot. Observe the performance limits in the technical data. Repairs and installation, if necessary, should be performed by a specialist.

Declaration of conformity

The Blaupunkt GmbH declares that the Sevilla MP38 device complies with the basic requirements and the other relevant regulations of the directive 89/336/EWG.

For your safety

The device was manufactured according to the state of the art and established safety guidelines. Even so, dangers may occur if you do not observe the safety notes in these instructions:

If you are installing device yourself

You may only install the device yourself if you are experienced in installing car sound systems and are very familiar with the electrical system of the vehicle. For this purpose, observe the installation instructions at the end of these instructions.

Observe the following!



CAUTION

The device contains a Class 1 laser that can cause injuries to your eyes.

Do not open the device and do not perform any modifications.

In operation

- Operate the device only if traffic situation permits it! Stop at a suitable location to perform more extensive operations.
- Remove or attach the control panel only while the vehicle is standing an.
- To protect your hearing, always listen at a moderate volume. During mute phases (e.g. when changing the audio source or CD in the CD changer and Travelstore), changing the volume is not audible. Do not increase the volume during this mute phase.

- Always listen at a moderate volume so that you can always hear acoustic warning signals (e.g. police).

After operation

- The device is worthless to a thief without the control panel. Always remove the control panel whenever you leave the vehicle.
- Transport the control panel so that it is protected against impacts and the contacts cannot become dirty.

Cleaning instructions

Solvents, cleaning and scouring agents as well as dashboard spray and plastics care product may contain ingredients that will damage the surface of the device.

Use only a dry or slightly moistened cloth for cleaning the device.

Disposal of old unit



Do not dispose of your old unit in the household trash!

Use the return and collection systems available to dispose of the old device.

Scope of delivery

The scope of delivery includes:

- 1 car sound system
- 1 support frame
- 2 disassembly tools
- 1 guide pin
- 1 operating instructions

Optional equipment

(not part of the scope of delivery)

Use only accessories approved by Blaupunkt.

Remote control

The steering wheel and/or handheld remote control allows you to access the basic functions of your car sound system safely and conveniently.

You cannot switch the device on/off using the remote control!

You can find out from your Blaupunkt dealer or on the Internet at www.blaupunkt.com which remote controls can be used with your car sound system.

Amplifier

You can use all Blaupunkt and Velocity amplifiers.

CD changers

You can connect the following Blaupunkt CD changers:
CDC A 03, CDC A 08 and IDC A 09.

Warranty

We provide a manufacturer's warranty for products bought within the European Union. Devices purchased outside the European Union are subject to the warranty terms published by our respective regional agency.

The warranty terms can be called up under www.blaupunkt.com or requested directly from:

Blaupunkt GmbH
Hotline
Robert-Bosch-Str. 200
D-31139 Hildesheim, Germany

Service

In some countries, Blaupunkt offers a repair and pick-up service.

Information about the availability of this service in your country can be found at www.blaupunkt.com.

If you want to take advantage of this service, you may request a pick-up service for your device via the Internet.

Detachable control panel

Theft protection

The device is equipped with a detachable control panel (flip-release panel) as a way of protecting your equipment against theft. The device is worthless to a thief without this control panel.

Protect your device against theft by taking the control panel with you whenever you leave your vehicle. Do not leave the control panel inside your vehicle - not even in a hiding place.

Notes:

- Never drop the control panel.
- Do not expose the control panel to direct sunlight or another heat source.
- Avoid direct skin contact with the control panel's electrical contacts. If necessary, clean the contacts with a lint-free cloth moistened with cleaning alcohol.

Detaching the control panel

➔ Press the  button (1).

The control panel opens to the bottom.

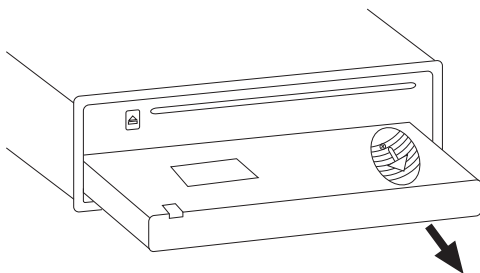

➔ Hold the control panel by its right side and then pull it **straight** out of the bracket.

Notes:

- The device is switched off after a time preset by you. For further details, please read the section "Switch-off time (OFF TIMER)" in this chapter.
- The device remembers the audio source played last for the next switch-on.
- Any CD already inserted in the device remains there.

Attaching the control panel

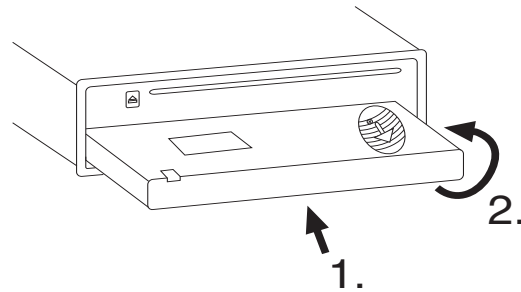

- ➔ Hold the control panel approximately at a right angle to the device. (see figure, 1.)
- ➔ Push the control panel into the guides at the bottom edge of the device.
- ➔ Push the control panel carefully into the bracket until it clicks into place.
- ➔ Fold the control panel up into the slot and press it gently into place until it clicks. (see figure, 2.)

If the device was still switched on when you detached the control panel, it will automatically switch on with the last setting activated (radio, CD, CD changer or AUX) when the panel is replaced.

Switch-off time (OFF TIMER)

After opening the control panel, the device is switched off after an adjustable time. You can set this time from 0 to 30 seconds.

- Press the **MENU•OK** button (5).
 - Press the **↵** or **↶** button (4) repeatedly until the displays shows "OFF TIMER".
 - Press the **>** button (4) to open the menu.
 - Set the time with the **↵** or **↶** button (4).
- When you have finished making your changes,
- press the **ESCAPE** button (12).

Timeout function

The device features a time-out function (time window).

For example, if you press the **MENU•OK** button (5) and select a menu item, the device switches back after approx. 8 seconds after the last button activation. The settings performed are saved.

Switching on/off

There are various ways of switching the device on/off:

Switching on/off with the On/Off button

- For switch-on, press the On/Off button (6).

The device switches on.

- To switch off the device, press and hold down the On/Off button (6) for longer than two seconds.

The device switches off.

Switching on/off using the vehicle ignition

The device will switch on/off simultaneously with the ignition if the device is correctly connected to the vehicle's ignition as shown in the installation instructions and you did not switch the device off by pressing the On/Off button (6).

Switching the device off using the detachable control panel

- Detach the control panel.

The device switches off after the time set in the "OFF TIMER" menu.

Note:

To protect the vehicle battery, the device will switch off automatically after one hour if the ignition is off.

Adjusting the volume

You can adjust the volume in increments from 0 (off) to 66 (maximum).

To increase the volume,

➔ turn the volume control (7) clockwise.

To decrease the volume,

➔ turn the volume control (7) counter-clockwise.

Setting the power-on volume

You can set the power-on volume.

➔ Press the **MENU•OK** button (5).

➔ Press the **∇** or **▲** button (4) repeatedly until "ON VOLUME" appears on the display.

➔ Press the **>** button (4) to open the menu item.

➔ Set the desired power-on volume with the button **∇** or **▲** (4).

To help you adjust the setting more easily, the device will increase or decrease the volume as you make your changes.

If you set "LAST VOL" (setting 0 = LAST VOL), the volume at which you were listening before power-off is activated again.

Note:

To protect your hearing, the power-on volume is limited to the value "38" for the setting "LAST VOL". If the volume was higher before switch-off, the value is automatically set to "38" at switch-on. This prevents an unintentionally and unexpectedly high volume when switching on the device.

When you have finished making your changes,

➔ press the **ESCAPE** button (12).

Quickly reducing the volume (MUTE)

You can quickly reduce the volume to a pre-set level.

➔ Briefly press the On/Off button (6).

"MUTE" appears on the display.

Cancelling mute

To return to your previously set volume level,

➔ briefly press the On/Off button (6) again.

Adjusting the mute level

You can adjust the mute level.

➔ Press the **MENU•OK** button (5).

➔ Press the **∇** or **▲** button (4) repeatedly until "MUTE LVL" appears on the display.

➔ Press the **>** button (4) to open the menu.

➔ Set the mute level with the **∇** or **▲** button (4).

When you have finished making your changes,

➔ press the **ESCAPE** button (12).

Telephone Audio/Navigation Audio

Muting during telephone mode

If your car sound system is connected with a cell phone or navigation system, "picking" up the phone or a voice output of the navigation system automatically mutes the car sound system. The call or the voice output is played back via the loudspeakers of the car sound system. For this purpose, the cell phone or the navigation system must be connected to the car sound system as described in the installation instructions.

You can find out from your Blaupunkt dealer which navigation systems can be used with your car sound system.

If you answer a call or a navigation announcement takes place, the display shows "PHONE".

Adjusting the volume for telephone audio/navigation audio

During a telephone call or a voice output of the navigation, no traffic announcements are switched through. The traffic announcement is not recorded!

You can set the volume level at which the telephone calls or navigation announcements are mixed in.

- ➔ Press the **MENU•OK** button (5).
- ➔ Press the **∨** or **∧** button (4) repeatedly until "TEL VOL" appears on the display.
- ➔ Press the **>** button (4) to open the menu.
- ➔ Set the desired volume with the **∨** or **∧** button (4).

When you have finished making your changes,

- ➔ press the **ESCAPE** button (12).

Note:

You can use the volume control (7) to adjust the volume of telephone calls and navigation announcements whilst you are listening to them.

Switching the confirmation beep on/off

The system will output a confirmation beep for some functions if you keep a button pressed down for longer than two seconds, for instance, when assigning a radio station to a station preset button. You can switch the beep on or off.

- ➔ Press the **MENU•OK** button (5).
- ➔ Press the **∨** or **∧** button (4) repeatedly until "BEEP ON" or "BEEP OFF" appears on the display.
- ➔ Switch the BEEP ON or OFF with the **>** or **<** button (4).

When you have finished making your changes,

- ➔ press the **ESCAPE** button (12).

Radio mode

This device is equipped with an RDS radio receiver. Many of the receivable FM stations broadcast a signal that not only carries the programme but also additional information such as the station name and programme type (PTY).

The station name appears on the display as soon as the tuner receives it.

Adjusting the tuner

To ensure proper functioning of the tuner, the device must be set for the region in which it is being operated. You can select among Europe "EUROPE", America "USA", Thailand "THAI", and South America "S-AMERIKA". The tuner is factory-set to the region in which it was sold. If you experience problems with your radio reception, please check this setting.

Note:

The radio functions described in these operating instructions refer to the tuner setting EUROPE.

➔ Switch off the device by pressing the On/Off button (6).

➔ Hold the buttons **1** and **5** (9) pressed at the same time and switch on the device again with the On/Off button (6).

"TUNER" appears on the display.

➔ Select your tuner region with the **∨** or **∧** button (4).

To save the setting,

➔ press the On/Off button (6) to switch the device off and on again. The radio starts playing with the last setting selected (radio, CD, CD changer or AUX).

Switching to radio mode

If you are in CD, CD changer or AUX mode,

➔ press the **BND** button (13)

or

➔ press the **SRC** button (2) repeatedly until the display shows "FM1", "FM2", "FMT", "MW" or "LW".

Convenient RDS functions (AF, REG)

The convenient RDS functions AF (Alternative Frequency) and REGIONAL extend your radio's range of functions.

- AF: If the RDS function is activated, the radio automatically tunes into the best receivable frequency for the station that is currently set.
- REGIONAL: At certain times, some radio stations divide their programme into regional programmes providing different content. You can use the REG function to prevent the car radio from switching to alternative frequencies that are transmitting different programme content.

Note:

REGIONAL must be activated/deactivated separately in the menu.

Switching REGIONAL on/off

➔ Press the **MENU•OK** button (5).

➔ Press the **∨** or **∧** button (4) repeatedly until "REG" appears on the display.

"OFF" or "ON" is displayed alongside "REG".

To switch REGIONAL on/off,

➔ press the **<** or **>** button (4).

When you have finished making your changes,

➔ press the **ESCAPE** button (12).

Switching the RDS function on/off

To switch the RDS functions AF and REGIONAL on or off,

➔ press and hold the **TRAF** button (3) for longer than two seconds.

If the RDS comfort function is active, the RDS symbol appears on the display.

Selecting the waveband/memory bank

This device can receive programmes broadcast over the FM frequency range as well as the MW and LW (AM) wavebands. There are three memory banks available for the FM waveband (FM1, FM2 and FMT) and one for each of the MW and LW wavebands.

Five stations can be stored in each memory bank.

To switch between the FM memory banks (FM1, FM2 and FMT) and the MW and LW wavebands,

➔ press the **BND** button (13).

Tuning into a station

There are various ways of tuning into a station.

Automatic station seek tuning

➔ Press the **∨** or **∧** button (4).

The radio tunes into the next receivable station.

Note:

If the priority for traffic information is active (the display shows the traffic jam symbol), the next traffic information station is set.

Tuning into stations manually

You can also tune into stations manually.

Note:

You can only tune into stations manually if the convenient RDS function is deactivated.

To change the set frequency in small increments,

➔ briefly press the **< or >** button (4).

To change the set frequency quickly,

➔ press and hold down the **< or >** button (4) for a longer period of time.

Browsing through broadcasting networks (FM only)

If a radio station provides several programmes, you have the option of browsing through its so-called "broadcasting network".

Note:

The convenient RDS function must be activated before you can use this feature.

➔ Press the **< or >** button (4) to switch to the next station on the broadcasting network.

Note:

When using this feature, you will only be able to switch to stations that you have received once before already. To

receive the stations, use the Scan or Travelstore function.

Setting the sensitivity of station seek tuning

You can choose whether the radio should only tune into stations providing good reception or whether it can also tune into those with a weak reception.

- ➔ Press the **MENU•OK** button (5).
- ➔ Press the **∨** or **∧** button (4) repeatedly until "SENS HI" or "SENS LO" appears on the display.

The display shows the currently set sensitivity level. "SENS HI6" indicates the highest sensitivity, "SENS LO1" the lowest.

- ➔ Set the desired sensitivity with the **<** or **>** button (4).

When you have finished making your changes,

- ➔ press the **ESCAPE** button (12).

Note:

The device stores the sensitivity value set in the respective FM and AM waveband.

Storing stations

Storing stations manually

- ➔ Select the desired memory bank (FM1, FM2, FMT) or one of the wavebands (MW or LW).
- ➔ Tune into the desired station.
- ➔ Press and hold down one of the station buttons **1 - 5** (9) for longer than two seconds to assign the station to that button.

Storing stations automatically (Travelstore)

You can automatically store the five stations offering the strongest reception in the region (FM only). The stations are stored in the FMT memory bank.

Note:

Any stations that were previously stored in this memory bank are deleted in the process.

- ➔ Press and hold down the **BND** button (13) for longer than 2 seconds.

The storing procedure begins. "FMTSTORE" appears on the display. After the process has completed, the radio will play the station that is stored in memory location 1 of the FMT memory bank.

Note:

If the priority for traffic information is active (the display shows the traffic jam symbol), only traffic information stations are stored.

Listening to stored stations

- ➔ Select the memory bank or waveband.
- ➔ Press one of the station buttons **1 - 5** (9).

The stored station is played if it can be received.

Scanning receivable stations (SCAN)

You can use the scan function to play all the receivable stations briefly. You can set the scanning time in the menu to between 5 and 30 seconds.

Starting SCAN

- Press and hold down the **MENU•OK** button (5) for longer than two seconds.

The radio scans the next receivable station. "SCAN" and the current frequency or the station name appear intermittently on the display.

Cancelling the SCAN and continuing to listen to a station

- Press the **MENU•OK** button (5).
- Scanning stops and the radio continues playing the station that it tuned into last.

Setting the scanning time

- Press the **MENU•OK** button (5).
- Press the **∨** or **∧** button (4) repeatedly until "SCAN TIME" appears on the display.
- Press the **>** button (4) to open the menu.
- Set the desired scan time with the **∨** or **∧** button (4).

When you have finished making your changes,

- press the **ESCAPE** button (12).

Note:

The defined scanning time is also applied by the system to scanning carried out in CD and CD-changer as well as MP3 mode.

Programme type (PTY)

Besides transmitting the station name, some FM stations also provide information on the type of programme that they are broadcasting. Your car radio can receive and display this information.

For example, the programme types can be:

| | | |
|---------|-----------|------|
| CULTURE | TRAVEL | JAZZ |
| SPORT | SERVICE | POP |
| ROCK | KNOWLEDGE | KIDS |

You can use the PTY function to select stations of a particular programme type.

PTY-EON

If you specify the programme type and start seek tuning, the radio will switch from the current station to a station of the selected programme type.

Notes:

- If the tuner does not find a station that corresponds to the selected programme type, you will hear a beep and "NO PTY" appears briefly in the display. The radio will then retune to the station that it received last.
- If the tuned radio station or another station on the broadcasting network broadcasts your selected programme type at a later point in time, the radio will automatically switch from the currently tuned station or from CD mode or CD-changer mode to the station whose programme type matches the one you selected.
- If you do not want this PTY EON switching, disable PTY. First, switch to radio mode using the **SRC** (2) or

BND button (13). In CD or CD changer mode, the menu item "PTY ON/ OFF" is not available.

Switching PTY on/off

- Press the **MENU•OK** button (5).
- Press the **∨** or **∧** button (4) repeatedly until "PTY" appears on the display with the current setting.
- Press the **<** or **>** button (4) to switch PTY ON or OFF.

When you have finished making your changes,

- press the **ESCAPE** button (12).

Selecting the PTY language

You can select the language for the display of the programme types. Options include DEUTSCH, ENGLISH and FRANÇAIS.

- Press the **MENU•OK** button (5).
- Press the **∨** or **∧** button (4) repeatedly until "PTY LANG" appears on the display.
- Set the desired language using the **<** or **>** button (4).

When you have finished making your changes,

- press the **ESCAPE** button (12).

Selecting a programme type and starting seek tuning

The current program type appears only briefly on the display.

- Press the **<** or **>** button (4).
- During the display time, press the **<** or **>** button (4) to change to a different program type.

- Press the **∨** or **∧** button (4) to start seek tuning.

The radio will then tune into the next station that it finds that corresponds to your selected programme type.

Optimising radio reception

Treble reduction feature during interference (High Cut)

The High Cut function results in an improved reception in case of weak radio reception (FM only). If reception interferences are present, the interference level is automatically reduced.

Switching High Cut on/off

- Press the **MENU•OK** button (5).
- Press the **∨** or **∧** button (4) repeatedly until "HICUT" appears on the display with the current setting.
- Press the **<** or **>** button (4) to switch High Cut on or off.

"HICUT 0" means no automatic reduction of the interference level, "HICUT 1" means automatic reduction of the interference level.

When you have finished making your changes,

- press the **ESCAPE** button (12).

Configuring the display

In radio mode, you can choose between various display options.

- Station name or frequency
- Memory location and time

To switch between the display options,

- press the **DIS** button (10).

Traffic information

Your device is equipped with an RDS-EON receiver. EON (**E**nhanced **O**ther **N**etwork) ensures that whenever a traffic announcement (TA) is broadcast, the system switches automatically from a station that does not provide traffic reports to the appropriate traffic information station within the broadcasting network that does.

Once the traffic report has been played, the system will switch back to the programme that you were listening to before.

Switching traffic information priority on/off

➤ Press the **TRAF** button (3).

The priority for traffic announcements is activated if the display shows the traffic jam symbol.

Notes:

You will hear a warning beep:

- If you leave the reception area of a traffic information station that you are currently listening to.
- If you leave the reception area of a traffic information station that the system is tuned into while you are in the CD or CD changer mode, and the subsequent automatic seek tuning cannot find a new traffic information station.
- If you retune the radio from a traffic information station to a station that does not broadcast traffic information.

If you hear the warning beep, you can either switch off traffic information priority or tune into a station that broadcasts traffic information.

Setting the volume for traffic announcements

➤ Press the **MENU•OK** button (5).

➤ Press the **∨** or **∧** button (4) repeatedly until "TA VOLUME" appears on the display.

➤ Press the **>** button (4) to open the menu.

➤ Set the volume with the **∨** or **∧** button (4).

To help you adjust the setting more easily, the device will increase or decrease the volume as you make your changes.

When you have finished making your changes,

➤ press the **ESCAPE** button (12).

Notes:

- Using the volume control (7), you can also adjust the volume during a traffic announcement for the duration of that announcement.
- During traffic reports, you can adjust the sound settings and volume distribution settings for traffic announcements. For further information, please read the "Sound" chapter.

CD mode

You can use this device to play standard audio CDs, CD-Rs and CD-RWs with a diameter of 12 or 8 cm.



Caution!

Labelled or shaped CDs can damage the CD drive.

- Do not insert any shape CDs.
- Do not attach labels to CDs since the label may detach during operation.

Note:

Label CDs only by using a marker since it does not contain any caustic materials. Permanent markers can damage CDs.

To ensure proper functioning, use only CDs with the Compact-Disc logo. Copy-protected CDs can cause playback problems. Blaupunkt cannot guarantee the proper functioning of copy-protected CDs!

Besides being able to play audio CDs on this device, you can also play CDs containing MP3/WMA music files. For further information, please read the chapter entitled "MP3/WMA mode".

Switching to CD mode

If there is no CD inserted in the drive,

➔ press the  button (1).

The control panel opens.

➔ Gently insert the CD with its printed side uppermost into the drive until you feel some resistance.

The drive draws in the CD automatically.

If the CD is not automatically drawn in,

➔ briefly press the  button (15).

You must not hinder or assist the drive as it draws in the CD.

➔ Gently close the control panel whilst exerting a little pressure until you feel it click into place.

The CD playback starts and "CD" is shown on the display.

Note:





If the vehicle ignition was switched off prior to inserting the CD, you must switch the device on first with the On/Off button (6) to start the playback.

If a CD is already inserted in the drive,

➔ press the **SRC** button (2) repeatedly until "CD" appears on the display.

Playback begins from the point at which it was last interrupted.



Selecting tracks

➔ Press one of the arrow keys  or  (4) or  or  (4) to select the next or previous track.

If you press the  button (4) once, the current track will be played again from the beginning.

Fast seek tuning (audible)

To fast search backwards or forwards,

➔ press and hold down the  or  button (4) until fast searching backwards/forwards begins.

Random track play (MIX)

➡ Press the **5 MIX** button (9).

"MIX CD" appears briefly on the display and the MIX symbol is displayed. The next randomly selected track will then be played.

Cancelling MIX

➡ Press the **5 MIX** button (9) again.

"MIX OFF" appears briefly on the display and the MIX symbol disappears.

Scanning tracks (SCAN)

You can scan (briefly play) all the tracks on the CD.

➡ Press the **MENU•OK** button (5) for longer than two seconds.

The next track will then be scanned. "SCAN" appears on the display and the current track number is flashing.

Note:

You can set the scan time. For further information, please read the section entitled "Setting the scanning time" in the "Radio mode" chapter.

Cancelling Scan and continuing listening to a track

To end the scanning process,

➡ press the **MENU•OK** button (5).

The currently scanned track will then continue to be played normally.

Repeating tracks (REPEAT)

If you want to repeat a track,

➡ press the **4 RPT** button (9).

"RPT TRCK" appears briefly on the display and the RPT symbol is displayed. The track is repeated continuously until you deactivate Repeat.

Cancelling Repeat

If you want to cancel the repeat function,

➡ press the **4 RPT** button (9) again.

"RPT OFF" appears briefly on the display and the RPT symbol disappears. Normal playback is then resumed.

Interrupting playback (PAUSE)

➡ Press the button **3 ||▶** (9).

"PAUSE" appears on the display.

Cancelling pause

➡ During the pause, press the button **3 ||▶** (9).

Playback is continued.

Configuring the display

You can choose from various display options in CD mode:

- Track number and playing time
- Track number and time

To switch between the display options,

➡ press the **DIS** button (10).

Displaying CD text

Some CDs include CD text. The CD text might contain the names of the artist and the album.

The CD text is shown as scrolling text on the display with every track change.

Switching CD text on/off

- ➔ Press the **MENU•OK** button (5).
- ➔ Press the **↵** or **↶** button (4) repeatedly until "CD TEXT" appears on the display with the current setting.
- ➔ Press the **➤** button (4) to open the menu.
- ➔ Select between the options "TEXT ON" (display CD text) or "TEXT OFF" (do not display CD text) with the **↵** or **↶** button (4).

When you have finished making your changes,

- ➔ press the **ESCAPE** button (12).

Traffic announcements in CD mode

If you wish to receive traffic announcements in CD mode,

- ➔ Press the **TRAF** button (3).

The priority for traffic announcements is activated if the display shows the traffic jam symbol. For further details, please read the chapter entitled "Traffic information".

Ejecting a CD

- ➔ Press the **⏏** button (1).
- The control panel opens to the bottom.
- ➔ Press the button **▲** (15) next to the CD compartment.
- The CD is ejected.
- ➔ Remove the CD and close the control panel.

Notes:

- If a CD is ejected, the drive will automatically draw it back in again after 10 seconds.
- You can also eject CDs whilst the device is switched off or whilst another audio source is activated.

MP3/WMA mode

You can also use this car sound system to play CD-Rs and CD-RWs that contain MP3 music files. You can also play WMA files.

This chapters deals only with playing MP3 files since the operation for MP3 and WMA files is identical.

Notes:

- WMA files with Digital Rights Management (DRM) from online music shops cannot be played with this device.
- WMA files can only be played back safely if they were created with Windows Media Player version 8 or later.

Preparing an MP3/WMA CD

The various combinations of CD burners, CD burning software and CD blanks may lead to problems arising with the device's ability to play certain CDs. If problems occur with your own burned CDs, you should try another brand of CD blank or choose another colour of CD blank.

The format of the CD must be ISO 9660 Level 1/Level 2 or Joliet. Other formats cannot be played reliably.

You can create a maximum of 252 directories on a CD. You can use this device to access all of these directories individually.

Regardless of the number of directories on the CD, the device can handle up to 511 MP3 files on a single CD, with a maximum of 255 files in one directory.

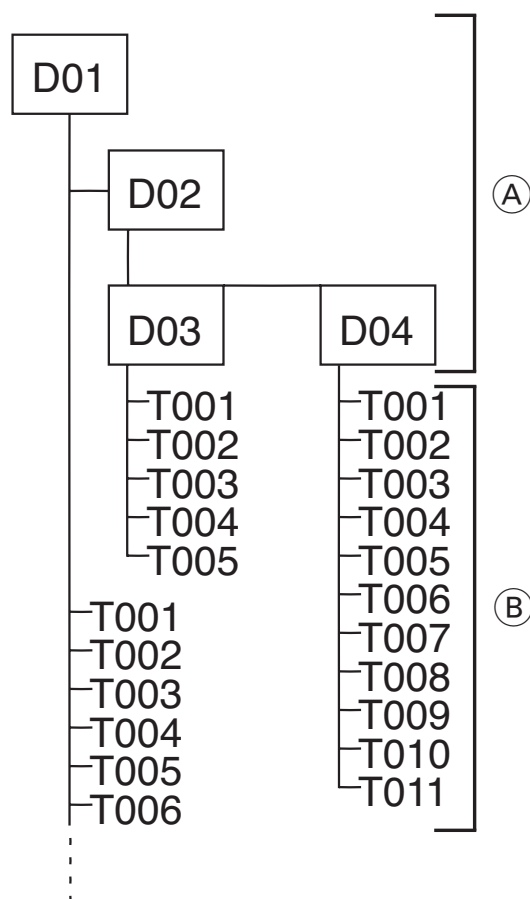

- (A) Directories
- (B) Tracks · Files

You can name each directory using a PC. The device is capable of displaying the directory name. Name the directories and tracks/files using your CD burner software. The software's instruction manual will provide details on how to do this.

Notes:

- When naming files (directories and tracks) you should avoid using accents and special characters.
- If you use file names with more than 16 characters (including ".MP3" or ".WMA"), the maximum number of tracks and directories is reduced.

If you like your files to be in the specific order, save the files on the data carrier in the desired sequence in which you want to play

them later. The device plays back the files in the order in which they were physically stored on the data carrier.

To play back files in this device, the MP3 files must have the file extension ".MP3" and the WMA files the file extension ".WMA".

Notes:

To ensure uninterrupted playback:

- Do not try changing the file extension to ".MP3" of any files other than MP3 files and then attempt to play them! The device will ignore these invalid files during playback.
- Do not use "mixed" CDs containing both non-MP3 data and MP3 tracks (the device only reads MP3 files during MP3 playback).
- Do not use mix-mode CDs containing both CD-audio tracks and MP3 tracks. If you try playing a mix-mode CD, the device will only play the CD-audio tracks.

MP3 ID3 tags

MP3 tracks can contain additional information such as the artist, album and track name (ID3 tags). This device can display ID3 tags of version 1 and 2.

Switching to MP3 mode

MP3 mode is activated in the same way as normal CD mode. For further information, please read the section entitled "Switching to CD mode" in the "CD mode" chapter.

Configuring the display

The following settings require that an MP3 CD is in the device.

Configuring the default display

You can display various types of information on the current track:

- Directory number and track number "DIR-TRCK"
- Directory number and time "DIR-CLK"
- Directory number and playing time "DIR-TIME"
- Track number and playing time "TRCK-TIME"
- Track number and time "TRCK-CLK"

Note:

After the MP3 scrolling text was scrolled once after a track change, the information is permanently shown on the display.

To switch between the different display options,

- ➔ press the **DIS** button (10) once or several times until the desired display appears.

Configuring the MP3 scrolling texts

One of the following scrolling texts is shown once on the display with every track change. Afterwards, the configured standard display is shown.

The available scrolling texts are:

- Directory name ("DIR NAME")
- Name of the track ("SONG NAME")
- Name of the album ("ALBM NAME")
- Name of the artist ("ARTIST")

- File name ("FILE NAME")

Note:

Artist, track and album name are part of the MP3-ID tag of version 1 and can only be displayed if they have been saved with the MP3 files (for further information, please read the instructions that came with your PC's MP3 software or burner software).

To switch between the different display options,

- press the **MENU•OK** button (5).
- Press the **↓** or **↑** button (4) repeatedly until "MP3 DISP" appears on the display.
- Press the **➤** button (4) to open the menu.
- Select the desired MP3 scrolling text with the **↓** or **↑** button (4).

When you have finished making your changes,

- press the **ESCAPE** button (12).

Selecting a directory

To move up or down to another directory,

- press the **↓** or **↑** button (4) once or several times.

Selecting Tracks/Files

to move up or down to another track/file in the current directory,

- press the **<** or **>** button (4) once or several times.

If you press the **<** button (4) once, the current track will be played again from the beginning.

Fast search

To fast search backwards or forwards,

- press and hold down the **<** or **>** button (4) until fast searching backwards / forwards begins.

Random track play (MIX)

To play the tracks in the current directory in random order,

- briefly press the **5 MIX** button (9).

"MIX DIR" appears on the display and the MIX symbol lights up.

To play all the tracks contained on the inserted MP3 CD in random order,

- press and hold down the **5 MIX** button (9) for longer than two seconds.

"MIX CD" appears on the display and the MIX symbol lights up.

Cancelling MIX

To cancel MIX,

- briefly press the **5 MIX** button (9).

"MIX OFF" appears on the display and the MIX symbol disappears.

Scanning tracks (SCAN)

You can scan (briefly play) all the tracks on the CD.

- Press and hold down the **MENU•OK** button (5) for longer than two seconds. The next track will then be scanned.

"TRK SCAN" briefly appears on the display. The currently active track number flashes. The titles of the CD are scanned in ascending order.

Note:

You can set the scanning time. For further information on setting the scanning time, please read the section entitled "Setting the scanning time" in the "Radio mode" chapter.

Cancelling SCAN and continuing listening to a track

➤ Briefly press the **MENU•OK** button (5).

The currently scanned track will then continue to be played normally.

Repeating individual tracks or whole directories (REPEAT)

To play the current track repeatedly,

➤ briefly press the **4 RPT** button (9).

"RPT TRCK" appears briefly on the display and RPT lights up.

To repeat the whole directory,

➤ press and hold down the **4 RPT** button (9) for longer than two seconds.

"RPT DIR" appears briefly on the display.

Cancelling REPEAT

To stop the current track or current directory from being repeated,

➤ briefly press the **4 RPT** button (9).

"RPT OFF" appears briefly on the display and RPT disappears.

Interrupting playback (PAUSE)

➤ Press the button **3**  (9).

"PAUSE" appears on the display.

Cancelling pause

➤ During the pause, press the button **3**  (9).

Playback is continued.

CD-changer mode

Note:

Information on handling CDs, inserting CDs and operating the CD changer can be found in the operating instructions supplied with your CD changer.

Switching to CD-changer mode

➔ Press the **SRC** button (2) repeatedly until "CHANGER" appears on the display.

A border appears around the CD changer symbol.

The device starts playing the first CD that the CD changer detects.

Selecting CDs

To move up or down to another CD,

➔ press the **∨** or **∧** button (4) once or several times.

Note:

The device will ignore empty CD slots in the changer and slots containing invalid CDs.

Selecting tracks

To move up or down to another track on the current CD,

➔ press the **<** or **>** button (4) once or several times.

Fast searching (audible)

To fast search backwards or forwards,

➔ press and hold down one of the **<>** buttons (4) until fast searching backwards / forwards begins.

Configuring the display

Five options are available for the display in CD changer mode:

- CD number and track number ("CD-TRCK")
- CD number and time ("CD-CLK")
- CD number and playing time ("CD-TIME")
- Track number and playing time ("TRCK-TIME")
- Track number and time ("TRCK-CLK")

To switch between the display options,

➔ press the **DIS** button (10) once or several times until the desired display appears.

Repeating individual tracks or whole CDs (REPEAT)

To repeat the current track,

➔ briefly press the **4 RPT** button (9).

"RPT TRCK" appears briefly and RPT lights up on the display.

To repeat the current CD,

➔ press and hold down the **4 RPT** button (9) for longer than two seconds.

"RPT DISC" appears briefly and RPT lights up on the display.

Cancelling REPEAT

To stop the current track or current CD from being repeated,

➔ briefly press the **4 RPT** button (9).

"RPT OFF" appears and RPT disappears on the display.

Random track play (MIX)

To play the tracks on the current CD in random order,

➔ briefly press the **5 MIX** button (9).

"MIX CD" appears briefly and MIX lights up on the display.

To play the tracks on all inserted CDs in random order,

➔ press and hold down the **5 MIX** button (9) for longer than two seconds.

"MIX ALL" appears briefly and MIX lights up on the display.

Cancelling MIX

➔ Briefly press the **5 MIX** button (9).

"MIX OFF" appears and MIX on the display disappears.

Scanning all tracks on all CDs (SCAN)

To scan (briefly play) all the tracks on all the inserted CDs in ascending order,

➔ press and hold down the **MENU•OK** button (5) for longer than two seconds.

"TRK SCAN" appears on the display and the number of the current track flashes.

Stopping SCAN

To stop scanning,

➔ briefly press the **MENU•OK** button (5).

The currently scanned track will then continue to be played normally.

Note:

You can set the scanning time. For further information, please read the

section entitled "Setting the scanning time" in the "Radio mode" chapter.

Interrupting playback (PAUSE)

➔ Press the button **3 ||▶** (9).

"PAUSE" appears on the display.

Cancelling pause

➔ During the pause, press the button **3 ||▶** (9).

Playback is continued.

Clock – Time

Setting the time

To set the time,

- press the **MENU•OK** button (5).
- Press the **↗** or **↘** button (4) repeatedly until "CLOCK SET" appears on the display.
- Press the **>** button (4) to open the menu.

The time appears on the display. The minutes are flashing and can be adjusted.

- Set the time with the **↗** or **↘** button (4).

To switch between hours and minutes,

- press the **<** or **>** button (4).

When you have finished making your changes,

- press the **ESCAPE** button (12).

Selecting 12/24-hour clock mode

- Press the **MENU•OK** button (5).
- Press the **↗** or **↘** button (4) repeatedly until "24H MODE" or "12H MODE" appears on the display.
- Press the **<** or **>** button (4) to switch between the modes.

When you have finished making your changes,

- press the **ESCAPE** button (12).

Displaying the time continuously when the device is off and the ignition is on

To display the time when the device is off and the vehicle ignition is on,

- press the **MENU•OK** button (5).
- Press the **↘** or **↗** button (4) repeatedly until "CLOCK OFF" or "CLOCK ON" appears on the display.
- Press the **<** or **>** button (4) to switch the display between CLOCK ON and CLOCK OFF.

When you have finished making your changes,

- press the **ESCAPE** button (12).

Sound

You can adjust the sound settings (bass, middle and treble) separately for each source (radio, CD, CD changer, AUX, traffic announcement, telephone/navigation). The volume distribution settings (balance and fader) and X-BASS apply to all the audio sources except for traffic announcements and telephone/navigation. You can adjust the volume distribution settings separately for traffic announcements and telephone/navigation.

Note:

The settings of the sound for traffic announcements and telephone/navigation can only be made during a traffic announcement or during a telephone call/voice output.

Adjusting the bass

You can select 1 of 4 middle frequencies (60 Hz, 80 Hz, 100 Hz, 200 Hz). In addition, you can adjust the level between -7 and +7 for the selected bass frequency.

Adjusting bass frequency and level

- Press the **AUD** button (14).
- "BASS" appears on the display.
- Press the **>** button (4) once to reach the BASS submenu.
- Press the **<** or **>** button (4) repeatedly until the desired bass frequency appears on the display.
- Press the **↔** or **↵** button (4) to adjust the level between -7 and +7.
- Press the **AUD** (14) button twice to exit the menu.

Note:

If an Equaliser preset (POP, ROCK, CLASSIC) is selected, the manual increase of the bass level does not result in an audible change starting at a certain setting. For further information, please read the note in the section entitled "Equaliser presets".

Adjusting the middle

You can select 1 of 4 centre frequencies (500 Hz, 1 kHz, 2 kHz, 3 kHz). In addition, you can adjust the level between -7 and +7 for the selected centre frequency.

Adjusting centre frequency and level

- Press the **AUD** button (14).
- "BASS" appears on the display.
- Press the **↔** or **↵** button (4) repeatedly until "MIDDLE" appears on the display.
- Press the **>** button (4) once to reach the MIDDLE submenu.
- Press the **<** or **>** button (4) repeatedly until the desired centre frequency appears on the display.
- Press the **↔** or **↵** button (4) to adjust the level between -7 and +7.
- Press the **AUD** (14) button twice to exit the menu.

Adjusting the treble

You can select 1 of 4 treble frequencies (10 kHz, 12 kHz, 15 kHz, 17 kHz). In addition, you can adjust the level between -7 and +7 for the selected treble frequency.

Adjusting treble frequency and level

- Press the **AUD** button (14).
"BASS" appears on the display.
- Press the **↕** or **↗** button (4) repeatedly until "TREBLE" appears on the display.
- Press the **➤** button (4) once to reach the TREBLE submenu.
- Press the **◀** or **➤** button (4) repeatedly until the desired treble frequency appears on the display.
- Press the **↕** or **↗** button (4) to adjust the level between -7 and +7.
- Press the **AUD** (14) button twice to exit the menu.

Note:

If an Equaliser preset (POP, ROCK, CLASSIC) is selected, the manual increase of the treble level does not result in an audible change starting at a certain setting. For further information, please read the note in the section entitled "Equaliser presets".

Setting the left/right volume distribution (Balance)

To adjust the left/right volume distribution (balance),

- press the **AUD** button (14).
"BASS" appears on the display.
- Press the **↕** or **↗** button (4) repeatedly until "BAL" appears on the display with the current setting.
- Press the **◀** or **➤** button (4) to adjust the balance (right/left).
- Press the **AUD** (14) button to exit the menu.

Adjusting the front/rear volume distribution (Fader)

To adjust the front/rear volume distribution (fader),

- press the **AUD** button (14).
"BASS" appears on the display.
- Press the **↕** or **↗** button (4) repeatedly until "FADER" appears on the display with the current setting.
- Press the **◀** or **➤** button (4) to adjust the volume distribution front/rear.
- Press the **AUD** (14) button to exit the menu.

X-BASS

X-Bass allows you to increase the bass at low volume.

The selected X-Bass setting is effective for all audio sources (radio, CD, CD changer or AUX).

The X-BASS increase can be set in increments of 1 to 3.

"XBASS OFF" means that the X-BASS function is switched off.

Adjusting the X-BASS boost

➔ Press the **AUD** button (14).

"BASS" appears on the display.

➔ Press the **▲** or **▼** button (4) repeatedly until "X-BASS" appears on the display.

➔ Press the **➤** button (4) once to reach the X-BASS submenu.

➔ Press the **▲** or **▼** button (4) repeatedly until the desired setting appears on the display.

When you have finished making your changes,

➔ press the **AUD** button (14) twice.

Equalizer presettings (Presets)

This device features an equaliser in which the settings for the music genres "ROCK", "POP" and "CLASSIC" are already programmed.

To select an equaliser setting,

➔ press the **AUD** button (14).

"BASS" appears on the display.

➔ Press the **▲** or **▼** button (4) repeatedly until "POP", "ROCK", "CLASSIC" or "EQ OFF" appears on the display.

➔ Press the **<** or **>** button (4) to select one of the settings or select "EQ OFF" to switch off the equalizer.

When you have finished making your changes,

➔ press the **AUD** button (14).

Note:

Without Equaliser presets, you can adjust the bass and treble up to +7.

If you selected an Equaliser preset (POP, ROCK, CLASSIC), the adjustment of bass and treble is only limited. For example, the preset POP only allows for an audible treble adjustment up to +3.

Adjusting the display settings

Adjusting the display brightness

If your car sound system is installed as described in the installation instructions and your vehicle features the corresponding connection, the display brightness for day and night is switched by switching on the vehicle lighting. The display brightness can be adjusted separately for day and night in increments from 1 - 9.

- Press the **MENU•OK** button (5).
- Press the **↔** or **↕** button (4) repeatedly until "DIM DAY" or "DIM NIGHT" appears on the display.
- Press the **>** button (4) to open the menu.
- Press the **↔** or **↕** button (4) to switch between the brightness levels.

When you have finished making your changes,

- press the **ESCAPE** button (12).

Setting the display illumination colour

For the display illumination, you can mix a colour from the RGB spectrum (red green blue) or select a colour during a colour seek.

Mixing a colour for the display illumination

To customise the display illumination to suit your tastes you can mix a colour yourself using the three primary colours red, green and blue.

- Press the **MENU•OK** button (5).

- Press the **↔** or **↕** button (4) repeatedly until "DISP COL" appears on the display.
- Press the **>** button (4) to open the menu.

The menu for mixing your own colour is displayed. "R", "G", and "B" are displayed with the current values. The setting for "R" is activated.

- Press the **↔** or **↕** button (4) repeatedly until the desired colour value is displayed.
- Press the **<** or **>** button (4) to move the selection marker to the position after the other colours.
- Adjust the other colour components to suit your preferences.

When you have finished making your changes,

- press the **ESCAPE** button (12).

Selecting a display illumination during a colour scan

- Press the **MENU•OK** button (5).
- Press the **↔** or **↕** button (4) repeatedly until "COL SCAN" appears on the display.
- Press the **>** button (4) to start the colour seek.

The device starts changing the display illumination colour.

To select the currently set colour,

- press the **MENU•OK** button (5).

To start the seek tuning again,

- press the **>** button (4).

If you found the desired colour,

- press the **ESCAPE** button (12).

Activating/deactivating demo mode

In demo mode, the functions of the device are shown on the display as scrolling text. The constant colour change demonstrates the setting options of the display colours.

Pressing any button interrupts the demo mode for approx. 10 seconds.

Switching on the demo mode

- ➔ Switch off the device by pressing the On/Off button (6).
- ➔ Hold the buttons **1** (9) and **DIS** (10) pressed at the same time and switch on the device again with the On/Off button (6).

"DEMO" briefly appears on the display.

Switching off the demo mode

- ➔ Switch off the device by pressing the On/Off button (6).
- ➔ Hold the buttons **1** (9) and **DIS** (10) pressed at the same time and switch on the device again with the On/Off button (6).

The demo mode is switched off.

External audio sources

External audio sources, such as portable CD players, MiniDisc players or MP3 players, can be connected to the device via the rear AUX input (if no CD changer is connected to the device).

Notes:

- An adapter cable is needed to connect an external audio source via the rear AUX input. You can obtain this cable (Blaupunkt no.: 7 607 897 093) from your Blaupunkt dealer.
- The rear AUX input can be selected with the **SRC** button (2). "AUX INPUT" then appears on the display.
- AUX INPUT can be selected only if no CD changer is connected to the device.

Technical data

Amplifier

Output power: 4 x 18 watts sine at
14.4 V and
1% distortion factor
at 4 ohms.
4 x 26 watts sine
in accordance
with DIN 45324 at
14.4 V at 4 ohms.
4 x 50 watts
max. power

Tuner

Wavebands:
FM : 87.5 - 108 MHz
MW : 531 - 1 602 kHz
LW : 153 - 279 kHz
FM frequency response:
35 - 16,000 Hz

CD

Frequency response:
20 - 20,000 Hz

Pre-amp out

4 channels: 2 V

Input sensitivity

AUX input: 2 V / 6 k Ω
Tel./Navi input: 10 V / 1 k Ω

Weight approx. 1.36 kg

Subject to changes

Einbauanleitung



Sicherheitshinweise

Für die Dauer der Montage und des Anschlusses beachten Sie bitte folgende Sicherheitshinweise.

- Minuspol der Batterie abklemmen! Dabei die Sicherheitshinweise des Kfz- Herstellers beachten.
- Beim Bohren von Löchern darauf achten, dass keine Fahrzeugteile beschädigt werden.
- Der Querschnitt des Plus- und Minuskabels darf 1,5 mm² nicht unterschreiten.
- **Fahrzeugseitige Stecker nicht an das Radio anschließen!**
Die für Ihren Fahrzeugtyp erforderlichen Adapterkabel erhalten Sie im BLAUPUNKT-Fachhandel.
- Je nach Bauart kann Ihr Fahrzeug von dieser Beschreibung abweichen. Für Schäden durch Einbau- oder Anschlussfehler und für Folgeschäden übernehmen wir keine Haftung.

Sollten die hier aufgeführten Hinweise für Ihren Einbau nicht passen, so wenden Sie sich bitte an Ihren Blaupunkt-Fachhändler, Ihren Fahrzeughersteller oder unsere Telefon-Hotline.

Bei Einbau eines Amplifier oder Changers müssen unbedingt erst die Gerätemassen angeschlossen werden,

bevor die Stecker für die Line-In- oder Line-Out-Buchse kontaktiert werden.

Fremdgerätemassen dürfen nicht an der Autoradiomasse (Gehäuse) angeschlossen werden.

Installation instructions



Safety instructions

When carrying out installation work and making connections please observe the following safety instructions:

- Disconnect the negative terminal of the battery! When doing so, please observe the vehicle manufacturer's safety instructions.
- Make sure you do not damage vehicle components when drilling any holes.
- The cross sections of the positive and negative cables must not be less than 1.5 mm².
- **Do not connect the vehicle's plug connectors to the radio!**
You can obtain the adapter cable required for your vehicle type from any BLAUPUNKT dealer.
- Depending on the model, your vehicle may differ from the description provided here. We accept no responsibility for any damages due to incorrect installation or connection or for any consequential damages.

If the information provided here is not suitable for your specific installation requirements, please contact your Blaupunkt dealer, your vehicle manufacturer or our telephone hotline.

When installing an amplifier or changer, you must first connect the device earth connections before connecting the plugs for the line-in or line-out jacks.

Earth connection of external devices may not be connected to earth of car sound system (housing).

connexion et en cas de dommages consécutifs.

Si les indications décrites ici ne s'appliquent au montage que vous voulez effectuer, adressez-vous à votre revendeur Blaupunkt, votre constructeur automobile ou notre service d'assistance téléphonique.

Pour le montage d'un amplificateur ou changeur, les masses d'appareil doivent être d'abord connectées avant de connecter les fiches pour les connecteurs Line In ou Line Out.

Les masses des appareils externes ne doivent pas être raccordées à la masse de l'autoradio (boîtier).

F Notice de montage



Consignes de sécurité

Respecter les consignes de sécurité suivantes pendant la durée du montage et du branchement.

- Débrancher le pôle (-) de la batterie ! Respecter les consignes de sécurité du constructeur automobile !
- Veiller à n'endommager aucune pièce du véhicule en perçant des trous.
- La section du câble (+) et (-) ne doit pas dépasser 1,5 mm².
- **Ne pas brancher les connecteurs du véhicule sur la radio !**
Les câbles d'adaptation nécessaires pour le type de véhicule sont disponibles auprès des revendeurs BLAUPUNKT.
- En fonction du modèle, votre véhicule peut différer de cette description. Nous déclinons toute responsabilité en cas de dommages causés par des erreurs de montage ou de



I Istruzioni di installazione



Note di sicurezza

Durante il montaggio e l'allacciamento osservate per favore le seguenti istruzioni sulla sicurezza.

- Staccate il polo negativo della batteria! Nel fare ciò osservate le istruzioni di sicurezza del fabbricante d'auto.
- Quando praticate dei fori, fate attenzione a non danneggiare nessuna parte dell'autovettura.
- La sezione dei cavi positivi e negativi non deve essere mai inferiore a 1,5 mm².
- **Non collegate alla radio le spine in dotazione di autovettura!**
Richiedete ad un negoziante specializzato in articoli BLAUPUNKT il cavo

di adattamento richiesto per il vostro modello di autovettura.

- A seconda del modello il Suo veicolo può differire da questa descrizione. Non forniamo garanzia per danni derivanti da errori di montaggio o di collegamento e per danni conseguenti.

Se le indicazioni qui elencate non sono adatte al Suo montaggio, La preghiamo di rivolgersi al Suo rivenditore Blaupunkt, al fabbricante dell'auto o alla nostra hotline telefonica.

Quando vengono montati un amplificatore o un multiletto CD, bisogna innanzi tutto allacciare le masse degli apparecchi prima di eseguire la connessione delle spine con le prese line-in e line-out.

Le masse di altri apparecchi non devono essere collegate alla massa dell'autoradio (involucro).

Inbowhandleiding

Adviezen voor de veiligheid

Wilt u dedurende het monteren en aansluiten de volgende veiligheidsadviezen in acht nemen.

- De minpool van de batterij afklemmen! De veiligheidsadviezen van de fabrikant in acht nemen.
- Bij het gaten boren erop letten dat geen voertuigonderdelen worden beschadigd.

- De dwarsdoorsnede van de plus- en minkabel mag niet minder dan 1,5 mm² zijn.

• **Stekker aan de voertuigkant niet aan de radio aansluiten!**

De voor uw voertuig vereiste adapterkabel is bij de BLAUPUNKT-vakhandel verkrijgbaar!

- Afhankelijk van de uitvoering kan uw auto afwijken van deze beschrijving. Voor schade door fouten in montage of aansluiting en schade als gevolg daarvan aanvaarden wij geen aansprakelijkheid.

Mochten de hier vermelde aanwijzingen voor de montage voor u niet van toepassing zijn, dan kunt u contact opnemen met uw Blaupunkt-vakhandel, uw autofabrikant of onze telefoon-hotline.

Bij inbouw van een versterker of cd-wisselaar moeten eerst de massacontacten van de apparaten worden verbonden voordat de stekkers voor de line-in- of line-out-bussen worden aangesloten.

De massa van andere apparaten mag niet aan de massa van de autoradio (huis) worden aangesloten.

Monteringsanvisning

Skyddsanvisningar

Vänligen beakta följande skyddsanvisningar under pågående montage och anslutning.

- Lossa polskon från batteriets minuspol! Följ därvid fordonstillverkarens skyddsanvisningar.

-
- Se till att inga av fordonets komponenter skadas i samband med borrar av hål.
 - Plus- och minuskabelns ledningsarea måste vara minst 1,5 mm².
 - **Fordonets stickkontakt får inte anslutas till radion!**
Din BLAUPUNKT fackhandel tillhandahåller för resp fordonstyp erforderlig adapterkabel.
 - Beroende på konstruktionstyp kan fordonet avvika från denna beskrivning. Vi fransäger oss allt ansvar för skada eller följdskada pga. felaktig montering eller anslutning.

Om här givna monteringsanvisningar ej stämmer överens med faktiska förhållanden, vänligen kontakta Blaupunkt fackhandel, representant för fordonets tillverkare eller vår telefonkundtjänst.

Vid montering av förstärkare eller cd-växlare måste först apparatstommen jordas, innan stickpropparna ansluts till in- eller utgångarna (hylstag line-in resp line-out).

Jord från andra apparater får inte anslutas till bilradions jord (höljet).

- Desemborne el polo negativo de la batería. Observe las normas de seguridad dadas por el fabricante del vehículo.
- Al perforar agujeros, asegúrese de no dañar ninguna pieza del vehículo.
- La sección transversal del cable positivo y del cable negativo no debe ser menor de 1,5 mm².
- **¡No conecte a la radio los conectores ubicados en el vehículo!**
Los cables adaptadores necesarios para su vehículo los encontrará en el comercio especializado en artículos de la marca BLAUPUNKT.
- Dependiendo del modelo, es posible que su vehículo varíe un poco con respecto a la descripción aquí dada. Tenga en cuenta que no asumimos ninguna responsabilidad por los daños debidos a un montaje o conexión incorrectos ni por los daños resultantes.

Si las instrucciones aquí dadas no son aptas para el montaje en su vehículo, póngase en contacto con su proveedor de artículos Blaupunkt o con el fabricante del vehículo, o llame a nuestro teléfono de atención al cliente.

En caso de montar un amplificador o un cambiadiscos, es necesario conectar la puesta a tierra de las unidades antes de establecer el contacto de los conectores para las hembrillas Line-In y Line-Out.

No deben conectarse masas de otros equipos a la masa de la radio (carcasa).

E Instrucciones de instalación



Normas de seguridad

Durante el montaje y la conexión es imprescindible observar las siguientes normas de seguridad.

Instruções de montagem



Instruções de segurança

Durante a montagem e a ligação do aparelho, queira respeitar as seguintes instruções de segurança.

- Separar o pólo negativo da bateria! Respeitar ao mesmo tempo as instruções de segurança do fabricante do automóvel.
- Quando se procede à furagem de buracos, prestar atenção para não serem danificadas quaisquer partes do veículo.
- As secções transversais dos cabos positivo e negativo não devem ser inferiores a 1,5 mm².
- **Não ligar as fichas existentes do lado do automóvel ao auto-rádio!**
Os cabos adaptadores necessários para o seu automóvel podem ser adquiridos nos revendedores da BLAUPUNKT.
- O seu veículo pode divergir desta descrição em função do modelo. Não assumimos qualquer responsabilidade por erros de montagem ou de ligação nem por danos daí decorrentes.

Caso as presentes instruções não sejam adequadas para a montagem no seu veículo, dirija-se ao revendedor da Blaupunkt, ao fabricante do seu veículo ou à nossa linha verde.

No caso de montagem de um amplificador ou leitor multi-CD, é imprescindível ligar primeiro os aparelhos à terra antes

de se conectar as fichas às tomadas Line In ou Line Out.

A massa de aparelhos externos não deve ser ligada à massa do auto-rádio (caixa).

Monteringsvejledning



Sikkerhedshenvisninger

Under monteringen og tilslutningen skal følgende sikkerhedshenvisninger iagttages.

- Batteriets negative pol skal afbrydes! Herved skal bilfabrikantens sikkerhedshenvisninger iagttages.
- Vær opmærksom på, at ingen bildele ødelægges under boringen af huller.
- Tværsnittet af plus- og minuskablet må ikke underskride 1,5 mm².
- **Bilens stik må ikke tilsluttes radioen!**
De nødvendige adapterkabler til din biltype kan købes hos BLAUPUNKT-specialforretningen.
- Alt efter konstruktion kan bilen afvige fra denne beskrivelse. For skader på grund af monterings- eller tilslutningsfejl og for følgeskader overtager vi intet ansvar.

Hvis de her anførte henvisninger til monteringen ikke skulle passe, kontakt din Blaupunkt-specialforretning, bilfabrikanten eller vor telefon-hotline.

Ved montering af en forstærker eller et Multi CD-apparat skal apparaternes stel

først tilsluttes, før stikkene for tilslutningerne Line-In eller Line-Out sættes i.

Eksterne enheders stelforbindelse må ikke sluttes til bilradioens stelforbindelse (kabinet).

PL Instrukcja montażowa

Wskazówki bezpieczeństwa

Podczas montażu i podłączania należy przestrzegać poniższych wskazówek bezpieczeństwa.

- Odłączyć biegun ujemny akumulatora! Przestrzegać wskazówek bezpieczeństwa producenta pojazdu.
- Przy wierceniu otworów uważać, aby nie uszkodzić któregoś z urządzeń pokładowych pojazdu.
- Przekrój kabla plusowego i minusowego nie może być mniejszy niż 1,5 mm².
- **Nie podłączać wtyczek samochodu do radia!**
Odpowiedni dla danego typu pojazdu przewód-adapter można nabyć u autoryzowanego sprzedawcy produktów BLAUPUNKT.
- Zależnie od marki i modelu, konstrukcja Państwa pojazdu może niekiedy odbiegać od podanego tu opisu. Firma Blaupunkt wyklucza wszelką odpowiedzialność za szkody spowodowane błędnym montażem i instalacją urządzenia.

W przypadku, gdy podane tu wskazówki nie znajdują zastosowania w Państwa pojeździe, prosimy skon-

taktować się z autoryzowanym sprzedawcą produktów Blaupunkt, producentem pojazdu lub zadzwonić do naszej infolinii.

Przy montażu wzmacniacza lub zmienarki należy koniecznie najpierw podłączyć masy urządzeń, zanim połączona zostanie wtyczka do gniazda Line-In lub Line-Out.

Do masy radioodtworacza (obudowa) nie wolno podłączać masy obcych urządzeń.

CZ Návod k montáži

Bezpečnostní pokyny

Během montáže a připojení dodržujte prosím následující bezpečnostní pokyny.

- Odpojte záporný pól akumulátoru! Přitom dodržujte bezpečnostní pokyny výrobce vozidla.
- Při vrtání otvorů dbejte na to, abyste nepoškodili žádné díly vozidla.
- Průřez kabelu plus a minus pólu musí být minimálně 1,5 mm².
- **Konektory od vozidla nepřipojujte k rádiu!**
Adaptérový kabel potřebný pro vaše vozidlo obdržíte ve specializované prodejně BLAUPUNKT.
- V závislosti na konstrukci se může postup u vašeho vozidla od zde popsaného postupu lišit. Za škody způsobené montáží nebo připojením nepřebíráme žádné ručení.

Pokud zde uvedené pokyny pro montáž neodpovídají vašemu vozidlu, obraťte se na specializovaného prodejce Blaupunkt, výrobce vozidla nebo naši horkou linku.

Při montáži zesilovače nebo měničů, předtím než budou konektory zapojeny do zdířek Line-in nebo Line-out, musí být nejprve bezpodmínečně připojeny kostry přístrojů.

Kostry jiných přístrojů nesmí být připojeny na kostru autorádia (kryt přístroje).

SK Montážny návod



Bezpečnostné pokyny

Počas montáže a zapojenia rešpektujte následné bezpečnostné pokyny.

- Odpojte záporný pól akumulátora! Rešpektujte pri tom bezpečnostné pokyny výrobcu vozidla.
- Pri vŕtaní otvorov dávajte pozor na to, aby sa nepoškodili žiadne diely vozidla.
- Prierez kábla kladného a záporného pólu nesmie byť menší ako 1,5 mm².
- **Koncovky elektroinštalácie vozidla sa do rádia nesmú zapojiť!** Potrebný kábel s adaptérom pre vaše vozidlo obdržíte v špecializovaných predajniach BLAUPUNKT.
- V závislosti od konštrukcie sa môže postup pri vašom vozidle od tu popísaného postupu líšiť. Za škody spôsobené montážou alebo neod-

borným pripojením nepreberáme záruku.

Ak by tu uvedené pokyny na montáž nezodpovedali vášmu vozidlu, obráťte sa prosím na špecializovaného predajcu fy Blaupunkt, výrobcu vášho vozidla alebo na našu zákaznícku linku.

Pri montáži zosilňovača alebo meniča je bezpodmienečne nutné najprv zapojiť kostru prístroja, než sa nakontaktujú zástrčky do zásuvky Line-In alebo Line-Out.

Kostry cudzích prístrojov sa nesmú napojiť na kostru (schránku) autorádia.



RUS Инструкция по установке



Указания по технике безопасности

Во время монтажа и подсоединения соблюдайте, пожалуйста, следующие указания по технике безопасности.

- Отсоедините минусовую клемму аккумулятора! Соблюдайте при этом правила техники безопасности завода-изготовителя Вашего автомобиля.
- При сверлении отверстий следите за тем, чтобы не повредить компоненты автомобиля.
- Сечение плюсового/минусового кабелей должен быть не меньше 1,5 мм².

- **Не включайте в аудиосистему автомобильные штекеры!**

Необходимые для Вашего типа автомобиля адаптерные кабели Вы можете приобрести в авторизованном сервисном центре Blaupunkt.

- Ваш автомобиль может - в зависимости от конструкции - отклоняться от данного описания. Завод-изготовитель аудиосистемы не несет ответственности за повреждения и-за ошибок при монтаже или подключении, а также за косвенный ущерб.

Если перечисленные здесь указания для Ваших условий монтажа не подходят, то обратитесь, пожалуйста, в авторизованный сервисный центр Blaupunkt или продавцу Вашего автомобиля.

При установке усилителя или чейнджера перед соединением штекеров гнезд линейного входа и выхода сначала нужно в обязательном порядке подключить массы устройств.

Запрещается подключение масс посторонних устройств к массе аудиосистемы (корпусу).

**Mitgelieferte Montage- und
Anschlussteile**

Supplied Mounting Hardware

Materiel de montage fourni

**Componenti di fissaggio comprese
nella fornitura**

Meegeleverde montagematerialen

Medföljande monteringsdetaljer

Ferretería de montaje suministrada

Elementos de fixação fornecidos

**Medleverede monterings- og
tilslutningsdele**

**Dołączone części montażowe i
połączeniowe**

**Přiložené montážní díly a přípojné
svorky**

**Dodávané montážne a pripojovacie
dielce**

**Поставляемые в комплекте
компоненты для установки и
подсоединения**

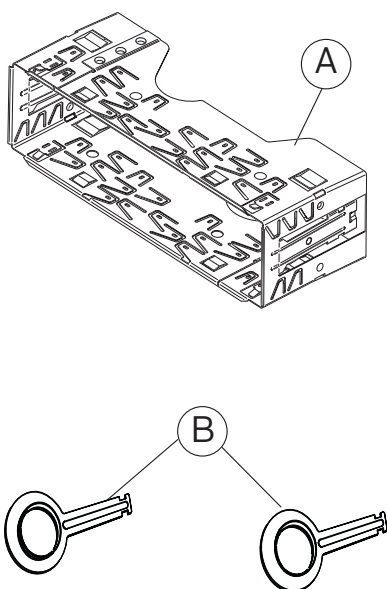

Als Sonderzubehör erhältlich

Available as an optional accessory

Disponibile en option

Reperibili come accessori extra

Als speciale accessoire verkrijgbaar

Tillval

De venta como accesorios especiales

**Disponíveis como acessórios
opcionais**

Fås som specialtilbehør

**Dostępne jako wyposażenie
dodatkowe**

**Jako zvláštní příslušenství můžete
obdržet**

**Ako osobitné príslušenstvo
dostanete**

**Поставляется как дополнительная
принадлежность**

Preamp./Sub./Center - out cable

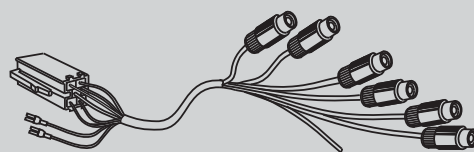

7 607 001 512

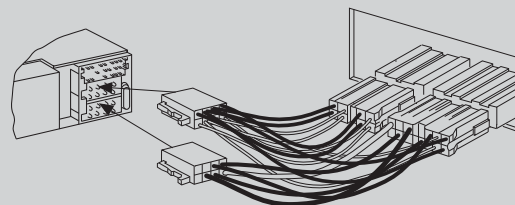

7 607 621 ...

Einbausätze

Installation kits

Kits de montage

Set di montaggio

Inbouwsets

Monteringsatser

Juegos de montaje

Kits de montagem

Indbygningssæt

Zestawy montażowe

Montážní soupravy

Montážne súpravy

Установочные комплекты

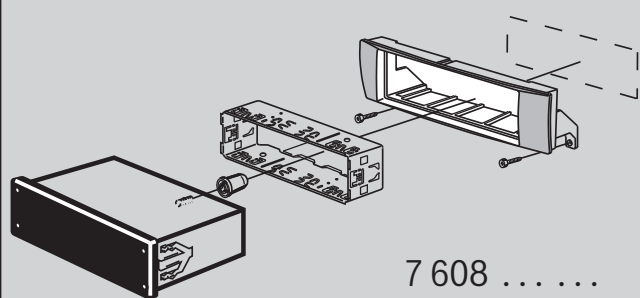

1.

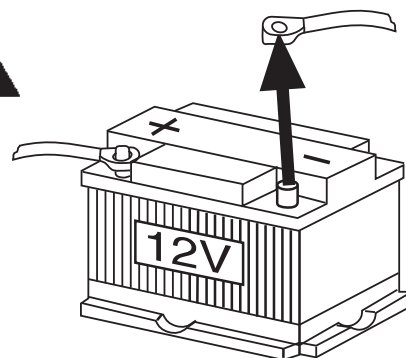

2.

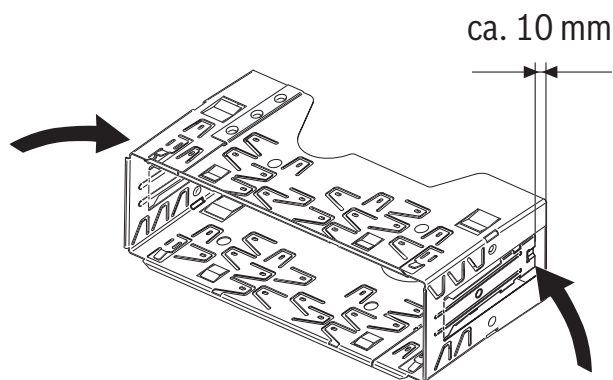

3.

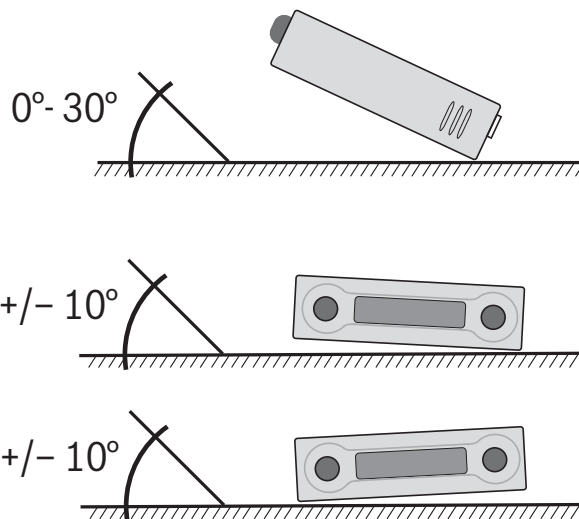

4.

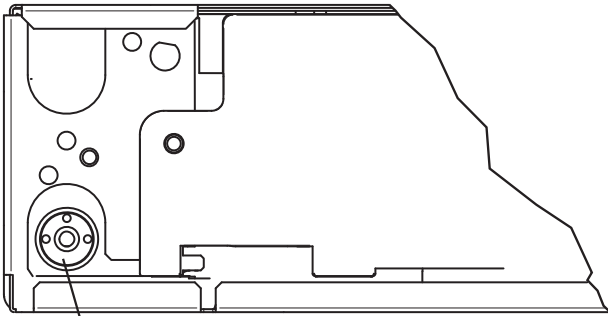

antenna connection

5.

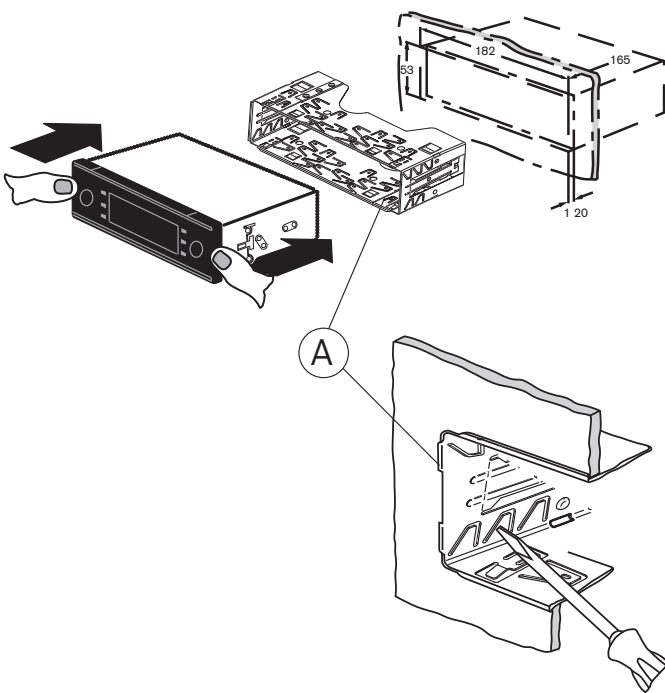

6. Ausbau / Removal / Démontage /
Smontaggio / Demontage /
Urmontering / Desmontaje /
Desmontagem / Udbygning /
Demontaž / Demontáž / Demontáž /
Демонтаж

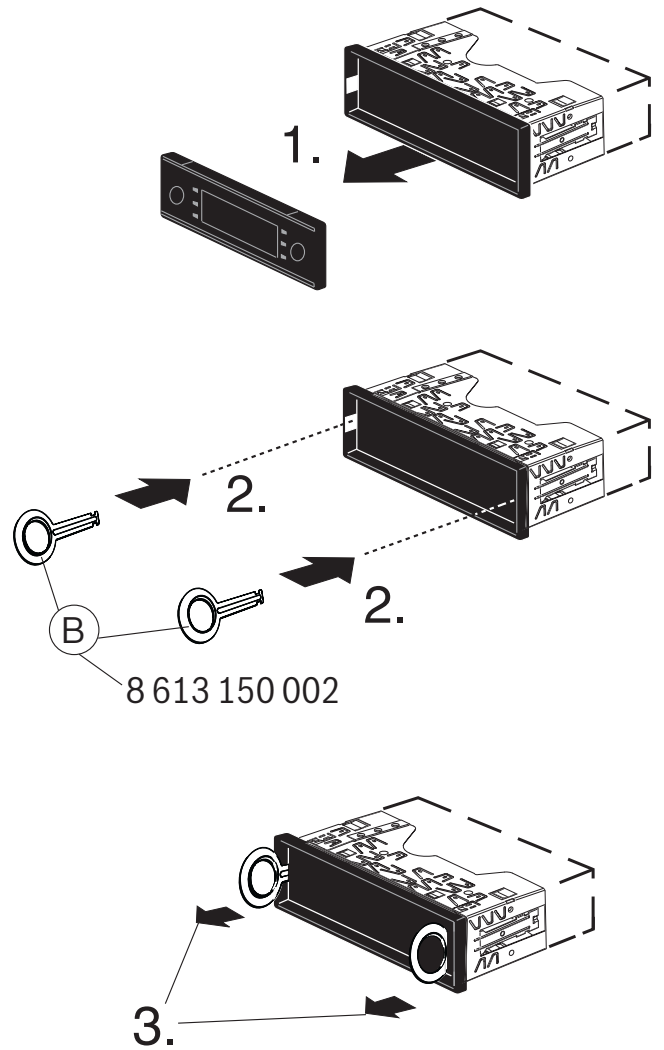

7.

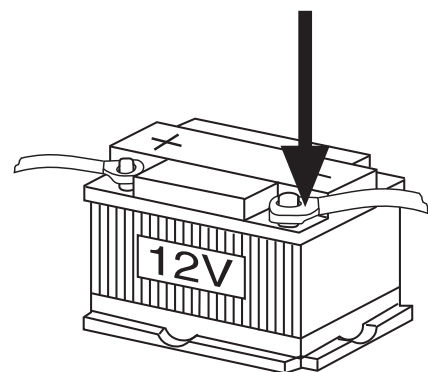

8.

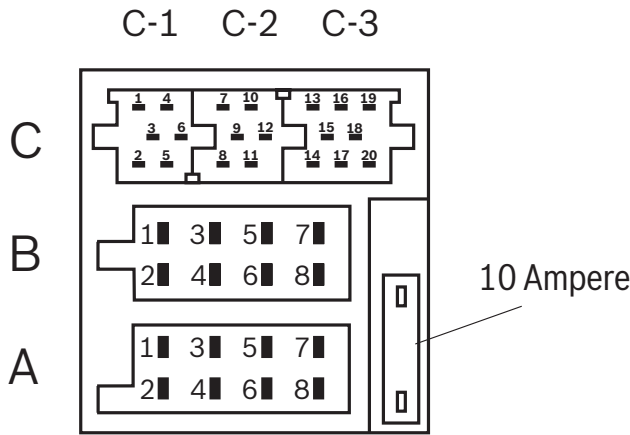

- Aut. antenna
- * FB +12V / RC +12V
- +12V Amplifier

- Summe
Sum
Somme
Somma
Som
Summa
Suma
Soma
Celkem
Súčet
Сумма
- 150 mA

| A | | B | |
|---|----------------|---|-----------------|
| 1 | NC | 1 | Speaker out RR+ |
| 2 | Radio Mute | 2 | Speaker out RR- |
| 3 | NC | 3 | Speaker out RF+ |
| 4 | Permanent +12V | 4 | Speaker out RF- |
| 5 | Aut. antenna * | 5 | Speaker out LF+ |
| 6 | Illumination | 6 | Speaker out LF- |
| 7 | Kl.15/Ignition | 7 | Speaker out LR+ |
| 8 | Masse/GND | 8 | Speaker out LR- |

| C1 | | C2 | | C3 | |
|----|--------------------------|----|-----------------------|----|-----------------------|
| 1 | Line Out LR | 7 | Telefon NF in + | 13 | CDC-Data In |
| 2 | Line Out RR | 8 | Telefon NF in - | 14 | CDC-Data Out |
| 3 | Line Out / Ground | 9 | Radio Mute | 15 | Permanent +12V |
| 4 | Line Out LF | 10 | SW Supply - RC +12V * | 16 | SW Supply +12V * |
| 5 | Line Out RF | 11 | Remote Control | 17 | Bus - Masse/GND |
| 6 | SW Supply +12V Amp. * | 12 | RC - GND | 18 | CDC/AUX1 Audio IN-GND |
| | | | | 19 | CDC/AUX1 Audio IN-L |
| | | | | 20 | CDC/AUX1 Audio IN-R |

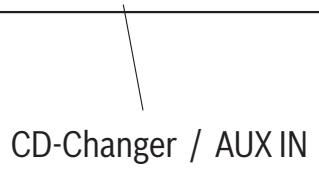
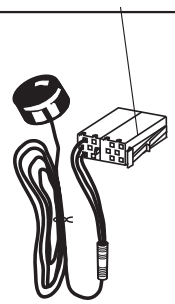
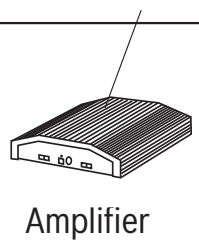

9.

Preamp./Sub./Center - out cable

7 607 001 512

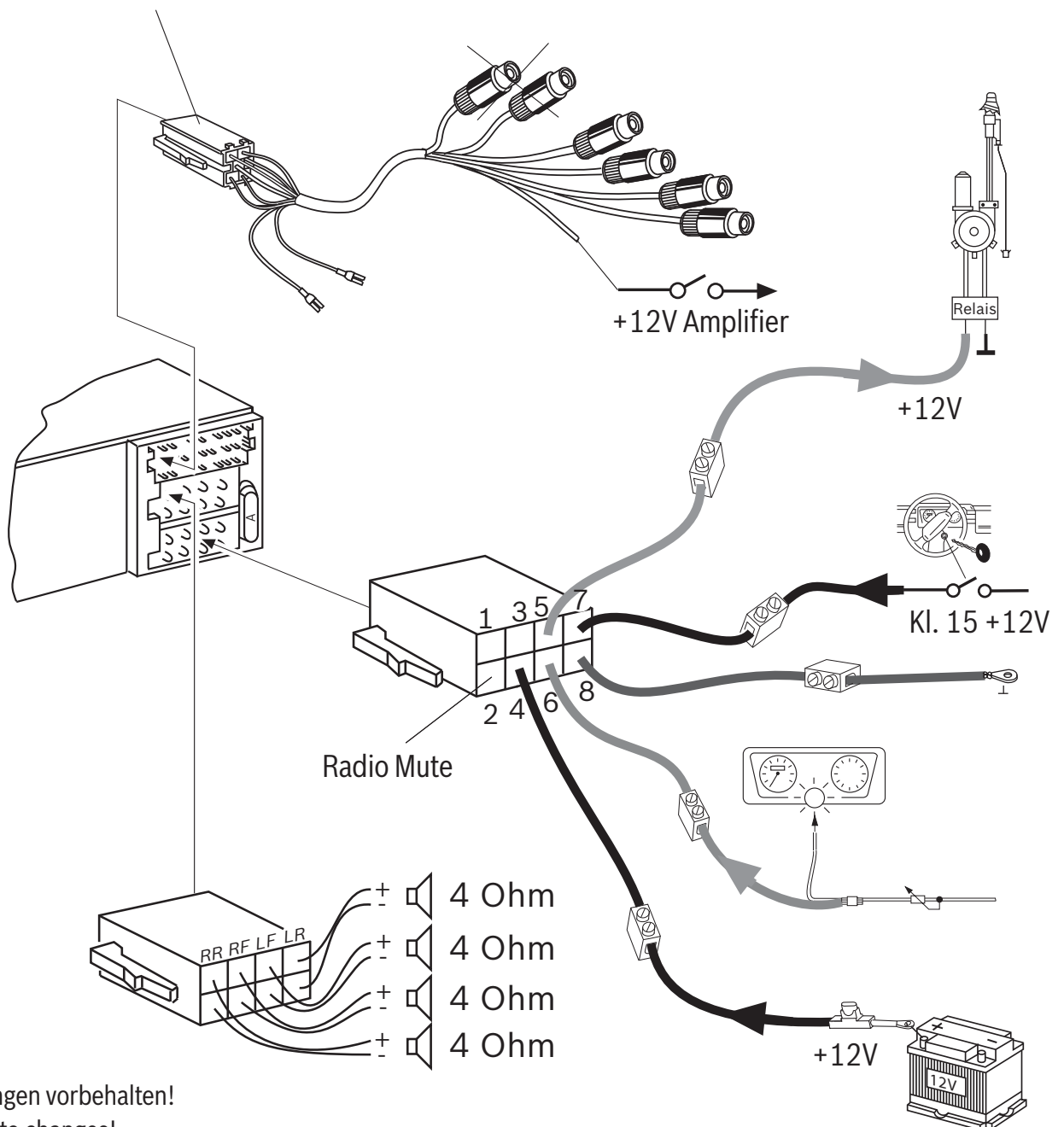

Änderungen vorbehalten!

Subject to changes!

Sous réserve de modifications!

Modifiche riservate!

Wijzigingen voorbehouden!

Ändringar förbehålles!

Modificaciones reservadas!

Sob reserva de alterações!

Ret til ændringer forbeholdes!

Zmiany techniczne zastrzeżone!

Změny vyhrazeny!

Zmeny vyhradené!

Завод-изготовитель оставляет за собой право на внесение изменений!

© 2007 All rights reserved by Blaupunkt. This material may be reproduced, copied or distributed for personal use only.

This product is protected by certain intellectual property rights of Microsoft. Use or distribution of such technology outside of this product is prohibited without a license from Microsoft.

Bitte den ausgefüllten Gerätepass sicher aufbewahren!
Please keep the filled-in radio pass in a safe place!
Prière de conserver soigneusement la carte d'autoradio remplie !
Tenete per favore il libretto di apparecchio, debitamente riempito, in un posto sicuro!
Bewaar de ingevulde apparaatpas op een veilige plaats!
Vänligen förvara ifyllt apparatpass på säker plats!
¡Favor guardar el documento del aparato debidamente llenado en un lugar seguro!
Por favor, guardar o cartão preenchido do aparelho num lugar seguro!
Det udfyldte apparatpas opbevares et sikkert sted!
Prosimy przechowywać metrykę radia w bezpiecznym miejscu!
Vyplněný dokument o přístroji prosím bezpečně uschovejte!
Vyplnený dokument o prístroji prosím bezpečne uschovajte!
Пожалуйста, храните заполненный паспорт устройства в надежном месте!

| Country: | Phone: | Fax: | WWW: |
|----------------------------|-------------------------|--------------------|---|
| Germany | (D) 0180-5000225 | 05121-49 4002 | http://www.blaupunkt.com |
| Austria | (A) 01-610 39 0 | 01-610 39 391 | |
| Belgium | (B) 02-525 5444 | 02-525 5263 | |
| Denmark | (DK) 44 898 360 | 44-898 644 | |
| Finland | (FIN) 09-435 991 | 09-435 99236 | |
| France | (F) 01-4010 7007 | 01-4010 7320 | |
| Great Britain | (GB) 01-89583 8880 | 01-89583 8394 | |
| Greece | (GR) 210 94 27 337 | 210 94 12 711 | |
| Ireland | (IRL) 01-46 66 700 | 01-46 66 706 | |
| Italy | (I) 02-369 62331 | 02-369 62464 | |
| Luxembourg | (L) 40 4078 | 40 2085 | |
| Netherlands | (NL) 00 31 24 35 91 338 | 00 31 24 35 91 336 | |
| Norway | (N) +47 64 87 89 60 | +47 64 87 89 02 | |
| Portugal | (P) 2185 00144 | 2185 00165 | |
| Spain | (E) 902 52 77 70 | 91 410 4078 | |
| Sweden | (S) 08-7501850 | 08-7501810 | |
| Switzerland | (CH) 01-8471644 | 01-8471650 | |
| Czech. Rep. | (CZ) 02-6130 0446 | 02-6130 0514 | |
| Hungary | (H) 76 889 704 | - | |
| Poland | (PL) 0800-118922 | 022-8771260 | |
| Turkey | (TR) 0212-335 07 23 | 0212-346 00 40 | |
| USA | (USA) 800-950-2528 | 708-6817188 | |
| Brasil (Mercosur) | (BR) 0800 7045446 | +55-19 3745 2773 | |
| Malaysia (Asia Pacific) | (MAL) +604-6382 474 | +604-6413 640 | |

10/07 - CM-AS/SCS1 (dt, gb, fr, it, nl, sw, es, pt, dk, pl, cz, sk, ru)

Gerätepass

Name: **Sevilla MP38**

Typ: **7 648 003 310**

Serien-Nr: **BP**

 **BLAUPUNKT**

